

NOTE THIS DRAWING IS FOR GUIDANCE ONLY AND MUST NOT BE USED AS A PROPER WORKING DRAWING. FOR ENQUIRIES ABOUT THE LIFT PLEASE CONTACT THE Platform Lift Co - TEL 01256 896000

Fig 1.1 - (Mounting to a wall)

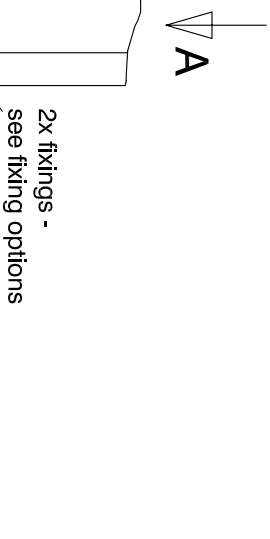

Force = 7100 + H x 650N
 F / 2 = Force at each leg
 H = Guide frame height

Fixing point = max 3m pitches

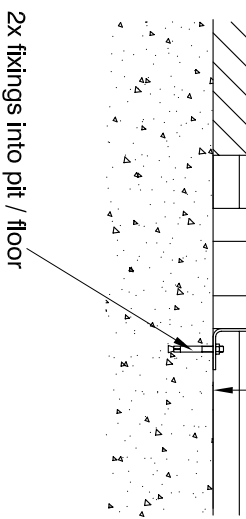

Fixing Options

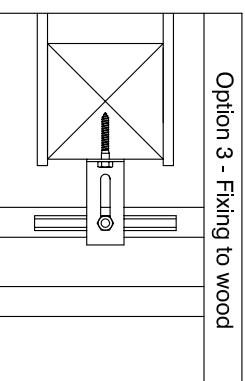
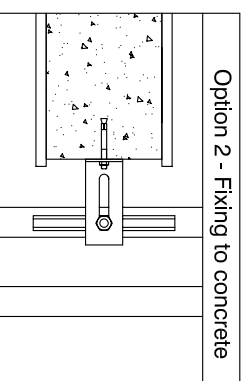
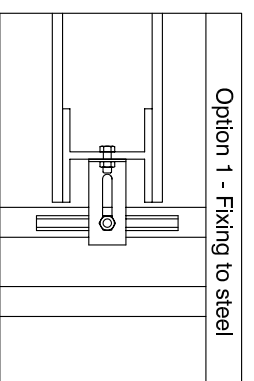
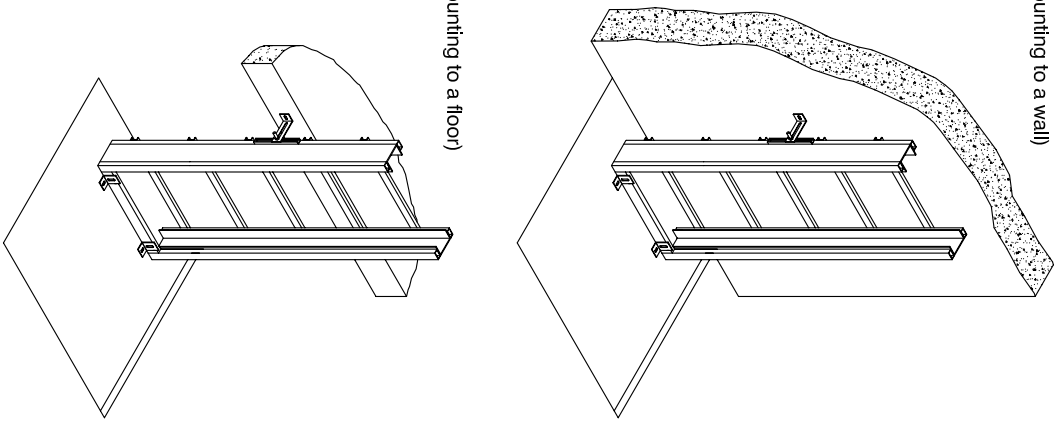
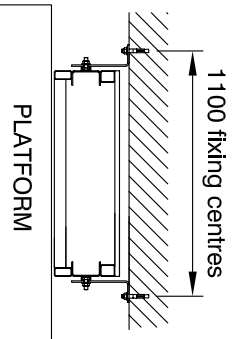

Fig 1.2 - (Mounting to a floor)



View on 'A'



		TITLE 400kg - A Type Pull Out Loads	
DWG NO. 400 - LOADS		REV A	
SCALE NTS	DATE 28/09/06	DRAWN RH	

Apsey Barrs, Apsey, Near
 Ardover, Hants, SP11 8NA
 Tel: 01256 896000
 Fax: 01256 896001
 Email: info@platformlift.co.uk
 website: www.platformlift.co.uk